

LED Shadow 2 ILS

User Manual



CHAUVET **2**

TABLE OF CONTENTS

1. Before You Begin	1
What Is Included	1
Unpacking Instructions.....	1
Claims	1
Text Conventions	1
Symbols	1
Disclaimer	1
Intellectual Property	1
Safety Notes.....	2
2. Introduction.....	3
Product Overview.....	3
Product Dimensions	3
3. Setup.....	4
AC Power	4
Fuse Replacement	4
Power Linking.....	4
Mounting	5
Orientation.....	5
Rigging	5
4. Operation.....	6
Control Panel Operation.....	6
Menu Map	6
Configuration (DMX)	6
Personality and Starting Address	6
D-Fi USB Connectivity	7
D-Fi USB Compatibility	7
Configuration (D-Fi USB)	7
D-Fi USB DIP Switch Channels.....	7
DMX Channel Assignments and Values	8
4Ch	8
Configuration (Standalone)	9
Static Color.....	9
Automatic Programs.....	9
Program Speed	9
Sound-Active Mode	9
Sound Sensitivity.....	9
Manual Mode	9
Configuration (Settings)	10
Dimmer Speed	10
Factory Reset.....	10
IRC-6 Infrared Remote Control	10
IRC-6 Operation	10
Master/Slave Mode (Wired)	11
Master/Slave Mode (D-Fi USB).....	11
ILS Mode.....	11
5. Maintenance	12
Product Maintenance	12
6. Technical Specifications.....	13
Warranty & Returns.....	14
Limited Warranty	14
Returns.....	14
Contact Us.....	15

1. Before You Begin

What Is Included

- LED Shadow 2 ILS
- Power cord
- Quick Reference Guide

Unpacking Instructions

Carefully unpack the product immediately and check the container to make sure all the parts are in the package and are in good condition.

Claims





If the box or the contents (the product and included accessories) appear damaged from shipping, or show signs of mishandling, notify the carrier immediately, not Chauvet. Failure to report damage to the carrier immediately may invalidate your claim. In addition, keep the box and contents for inspection.

For other issues, such as missing components or parts, damage not related to shipping, or concealed damage, file a claim with Chauvet within 7 days of delivery.

Text Conventions

Convention	Meaning
1–512	A range of values
50/60	A set of values of which only one can be chosen
Settings	A menu option not to be modified
<ENTER>	A key to be pressed on the product’s control panel
ON	A value to be entered or selected

Symbols

Symbol	Meaning
	Electrical warning. Not following these instructions may cause electrical damage to the product, accessories, or the user.
	Critical installation, configuration, or operation information. Not following these instructions may make the product not work, cause damage to the product, or cause harm to the operator.
	Important installation or configuration information. The product may not function correctly if this information is not used.
	Useful information.

Disclaimer

Chauvet believes that the information contained in this manual is accurate in all respects. However, Chauvet assumes no responsibility and specifically disclaims any and all liability to any party for any loss, damage or disruption caused by any errors or omissions in this document, whether such errors or omissions result from negligence, accident or any other cause. Chauvet reserves the right to revise the content of this document without any obligation to notify any person or company of such revision, however, Chauvet has no obligation to make, and does not commit to make, any such revisions. Download the latest version from www.chauvetdj.com.

Intellectual Property

The works of authorship contained in this manual, including, but not limited to, all design, text and images are owned by Chauvet.

© Copyright 2023 Chauvet & Sons, LLC. All rights reserved.

Electronically published by Chauvet in the United States of America.

CHAUVET, the Chauvet logo, and LED Shadow 2 ILS are registered trademarks or trademarks of Chauvet & Sons LLC (d/b/a Chauvet and Chauvet Lighting) in the United States and other countries. Other company and product names and logos referred to herein may be trademarks of their respective companies.

Safety Notes



- This product is not intended for permanent installation.
- Always connect the product to a grounded circuit to avoid the risk of electrocution.
- Always disconnect the product from the power source before cleaning or replacing the fuse.
- Avoid direct eye exposure to the light source while the product is on.
- Make sure the power cord is not crimped or damaged.
- Never disconnect the product from power by pulling or tugging on the cord.
- If mounting the product overhead, always secure to a fastening device using a safety cable.
- Make sure there are no flammable materials close to the product when operating.
- Do not touch the product's housing when operating because it may be very hot.



- The voltage of the outlet to which you are connecting this product must be within the range stated on the decal or rear panel of the product.
- The product is for indoor use only! (IP20) To prevent risk of fire or shock, do not expose the product to rain or moisture.
- Always install the product in a location with adequate ventilation, at least 20 in (50 cm) from adjacent surfaces.
- Be sure that no ventilation slots on the product's housing are blocked.
- Never connect the product to a dimmer or rheostat.
- Make sure to replace the fuse with another of the same type and rating.
- Never carry the product from the power cord or any moving part. Always use the handles.
- The maximum ambient temperature is 104 °F (40 °C). Do not operate this product at higher temperatures.
- In the event of a serious operating problem, stop using the product immediately.
- Do not open this product. It contains no user-serviceable parts.
- To eliminate unnecessary wear and improve its lifespan, during periods of non-use completely disconnect the product from power via breaker or by unplugging it.



Keep this User Manual for future use. If the product is sold to someone else, be sure that they also receive this document.

2. Introduction

Product Overview

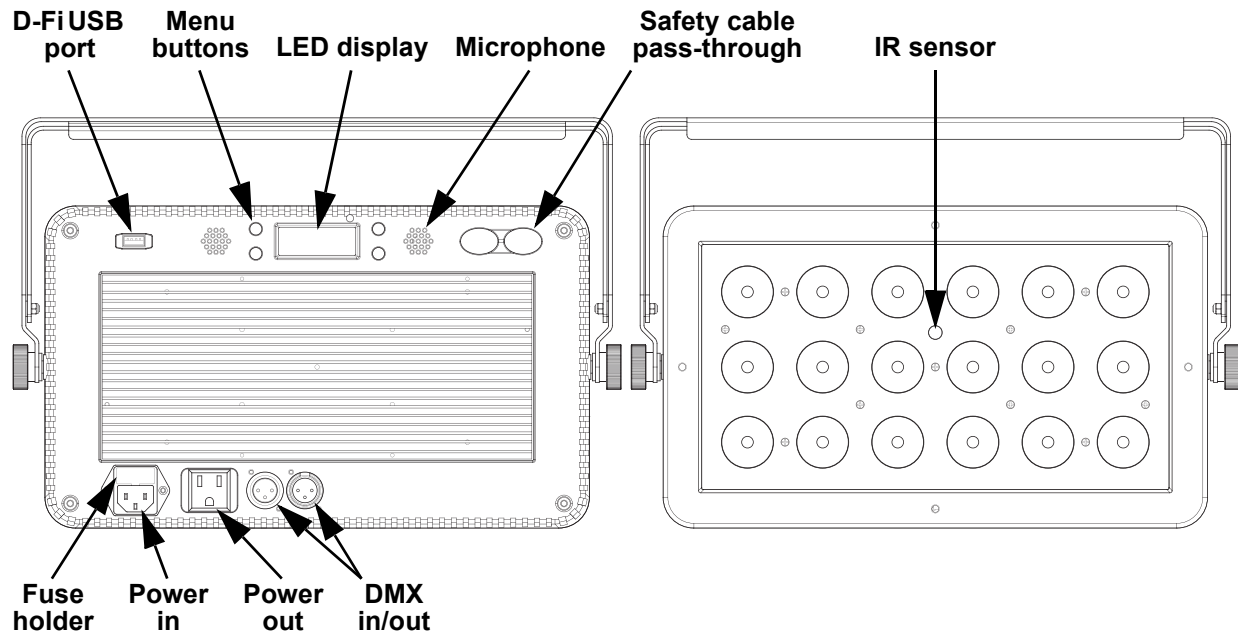

WARNING! DO NOT plug anything other than a D-Fi USB into the USB port. Doing so may cause damage to the product.

Product Dimensions

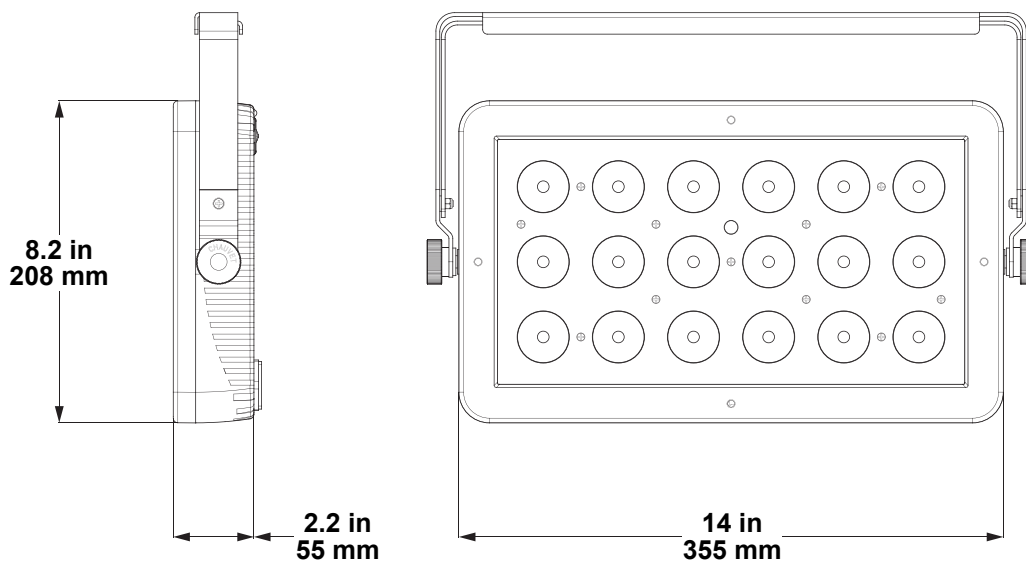

3. Setup

AC Power

The LED Shadow 2 ILS has an auto-ranging power supply and it can work with an input voltage range of 100 to 240 VAC, 50/60 Hz.

To determine the product's power requirements (circuit breaker, power outlet, and wiring), use the current value listed on the label affixed to the product's back panel, or refer to the product's specifications chart. The listed current rating indicates the product's average current draw under normal conditions.



- **Always connect the product to a protected circuit (a circuit breaker or fuse). Make sure the product has an appropriate electrical ground to avoid the risk of electrocution or fire.**
- **To eliminate unnecessary wear and improve its lifespan, during periods of non-use completely disconnect the product from power via breaker or by unplugging it.**



Never connect the product to a rheostat (variable resistor) or dimmer circuit, even if the rheostat or dimmer channel serves only as a 0 to 100% switch.

Fuse Replacement

1. Disconnect the product from power.
2. Using a flat-head screwdriver, unscrew the fuse holder cap from the housing.
3. Remove the blown fuse.
4. Replace with a fuse of the same type and rating.
5. Screw the fuse holder cap back in place and reconnect power.



Disconnect the product from the power outlet before replacing the fuse.

Power-Linking

The product provides power linking via the outlet located in the back of the product. See the diagram below for further explanation.

Power-Linking Diagram

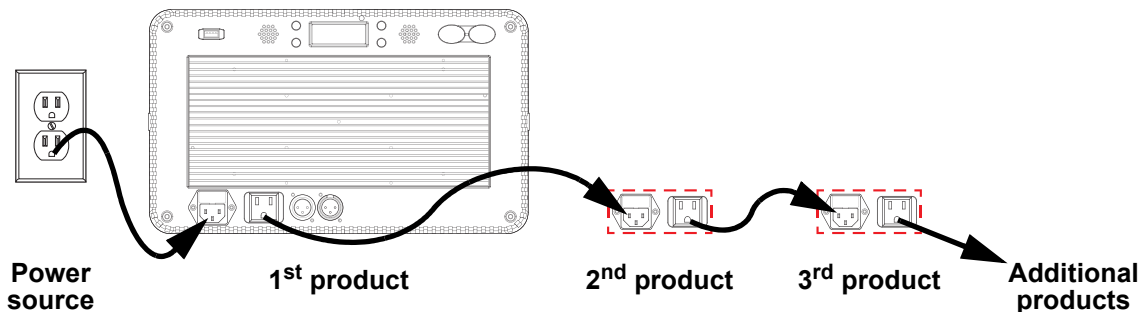

It is possible to power link up to 11 LED Shadow 2 ILS products on 120 VAC or up to 20 LED Shadow 2 ILS products on 230 VAC.



The power-linking diagram corresponds to the North American version of the product ONLY! If using the product in other markets, consult with the local Chauvet distributor as power-linking connectors and requirements may differ by country or region.

Mounting

Before mounting the product, read and follow the safety recommendations indicated in the [Safety Notes](#).

Orientation

The LED Shadow 2 ILS may be mounted in any position; however, make sure adequate ventilation is provided around the product.

Rigging

- Before deciding on a location, always make sure there is easy access to the product for maintenance and programming.
- Make sure adequate ventilation is provided around the product.
- Make sure that the structure or surface onto which the product is being mounted can support the product's weight. (see the [Technical Specifications](#))
- When mounting the product overhead, always use a safety cable. Mount the product securely to a rigging point, whether an elevated platform or a truss.
- When rigging the product onto a truss, use a mounting clamp of appropriate weight capacity.
- When power linking multiple products, mount the products close enough for power linking cables to reach.
- When mounting the product on the floor, make sure that the product and cables are away from people and vehicles.

Mounting Diagram

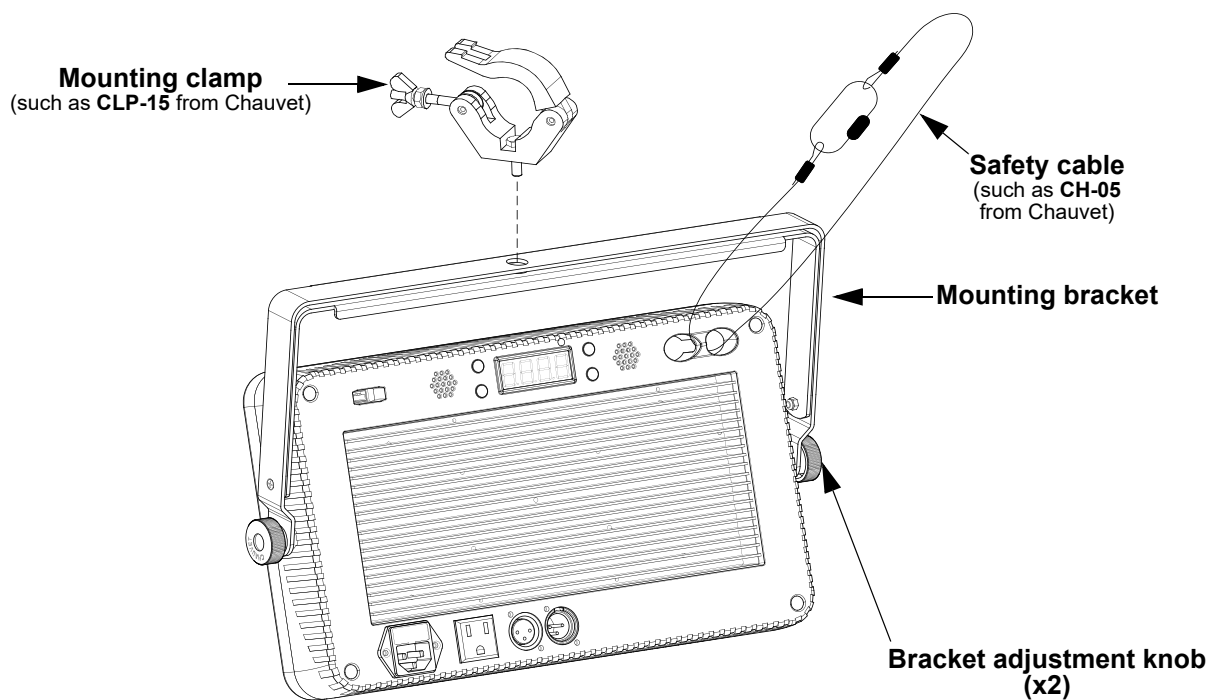

4. Operation

Control Panel Operation

To access the control panel functions, use the four buttons located underneath the display. Please refer to the [Product Overview](#) to see the button locations on the control panel.

Button	Function
<MENU>	Press to find an operation mode or to back out of the current menu option
<UP>	Press to scroll up the list of options or to find a higher value
<DOWN>	Press to scroll down the list of options or to find a lower value
<ENTER>	Press to activate a menu option or a selected value

Menu Map

Refer to the LED Shadow 2 ILS product page on www.chauvetdj.com for the latest menu map.

Mode	Programming Levels		Description	
DMX	4Ch	d 1–509	4-channel DMX mode	
Automatic Program	P--	P 1	3-zone chase 1	
		P 2	3-zone chase 2	
		P 3	3-zone fade	
		P 4	Pulse effect 0-100%	
		P 5	Pulse effect 0-100-0%	
		P 6	Strobe	
Speed	S--	S. 1–100	Automatic program speed	
Sound-Active	Snd	Snd1	Sound-active 3-zone chase 1	
		Snd2	Sound-active 3-zone chase 2	
		Snd3	Sound-active 3-zone fade	
		Snd4	Sound-active pulse effect 0-100%	
		Snd5	Sound-active pulse effect 0-100-0%	
		Snd6	Sound-active strobe	
Sensitivity	SEnS	u 0–100	Sound sensitivity	
Manual Mode	u--	u. 0–255	Manual dimmer	
		S. ___	S. 0	Manual strobe: off
			S. 1–99	Manual strobe: slow to fast
			S.100	Manual strobe: sound-active
Reset	SEt	rESt	Reset to factory default settings	
Infrared		ir	oFF on	Enables/disables infrared control
ILS	iLS	iLS1–4	Sets ILS mode	

Configuration (DMX)

The LED Shadow 2 ILS works with a DMX controller. Information about DMX is in the CHAUVET DMX Primer, which is available from the Chauvet website chauvetlighting.com/downloads/DMX_Primer_rev05_WO.pdf.

Personality and Starting Address

The LED Shadow 2 ILS uses up to 4 DMX channels in the **4Ch** mode, which defines the highest configurable address to **509**.

When selecting a starting DMX address, always consider the number of DMX channels the selected DMX mode uses. If the starting address is set too high, access to some channels could be restricted.

For information about the DMX protocol, download the DMX Primer from www.chauvetdj.com.

To select the personality and starting address, do the following:

1. Press **<MENU>** repeatedly until **4Ch** shows on the display.
2. Press **<ENTER>**.
3. Use **<UP>** or **<DOWN>** to select the starting address, from **d 1–509**.
4. Press **<ENTER>**.

D-Fi USB Connectivity

The LED Shadow 2 ILS is able to become a D-Fi wireless receiver/transmitter with the use of the D-Fi USB from Chauvet DJ. Simply set the product's DMX Personality and DMX Address, set the DIP switch D-Fi receiving/transmitting channel, then plug it into the D-Fi USB port.



WARNING! DO NOT plug anything other than a D-Fi USB into the USB port. Doing so may cause damage to the product.



Once plugged in, the D-Fi USB will take over the product. Wired DMX and manual display control / menu buttons will be unavailable until the D-Fi USB is unplugged. The priority levels are:

1. D-Fi USB
2. Wired DMX
3. Manual Digital Display/Menu Buttons

D-Fi USB Compatibility

The D-Fi USB can receive a DMX signal from the D-Fi Hub, the FlareCON Air 2, and other D-Fi USB products.

Configuration (D-Fi USB)

1. Set the DMX Personality and DMX address on the LED Shadow 2 ILS.
2. Use the Chart provided to set **BOTH**:
 - the Channel, and then
 - The Receiving or Transmitting option

NOTE: DIP Switch 5 is for Transmitting OR Receiving, please choose carefully.

D-Fi USB DIP Switch Channels

Receiving					Receiving					Transmitting					Transmitting								
Ch.	1	2	3	4	T/R	Ch.	1	2	3	4	T/R	Ch.	1	2	3	4	T/R	Ch.	1	2	3	4	T/R
1						9						1						9					
2						10						2						10					
3						11						3						11					
4						12						4						12					
5						13						5						13					
6						14						6						14					
7						15						7						15					
8						16						8						16					

DMX Channel Assignments and Values

4Ch

Channel	Function	Value	Percent/Setting
1	Program	000 ⇔ 004	No function
		005 ⇔ 039	P1: 3-zone chase 1
		040 ⇔ 079	P2: 3-zone chase 2
		080 ⇔ 119	P3: 3-zone fade
		120 ⇔ 159	P4: Pulse effect 0-100%
		160 ⇔ 199	P5: Pulse effect 0-100-0%
		200 ⇔ 239	P6: Strobe
		240 ⇔ 255	Sound-active (cycles P1-P5)
2	Program speed	000 ⇔ 255	Program speed, slow to fast
3	Strobe (when Ch. 1 is 005 ⇔ 199)	000	No function
		001 ⇔ 250	Strobe, slow to fast
		251 ⇔ 255	Sound-active strobe
	Lightning effect (when Ch. 1 is 200 ⇔ 239)	000	No function
		001 ⇔ 250	Lightning effect, slow to fast
		251 ⇔ 255	Sound-active lightning effect
4	Dimmer	000 ⇔ 255	0–100%

Configuration (Standalone)

Set the product in one of the standalone modes to control without a DMX controller.



Never connect a product that is operating in any standalone mode to a DMX string connected to a DMX controller. Products in standalone mode may transmit DMX signals that could interfere with the DMX signals from the controller.

Automatic Programs

To run the LED Shadow 2 ILS with an automatic program, do the following:

1. Press **<MENU>** repeatedly until **P--** shows on the display.
2. Press **<ENTER>**.
3. Use **<UP>** or **<DOWN>** to select a program, from **P 1–6**.
4. Press **<ENTER>**.

Program Speed

To set the program speed of the LED Shadow 2 ILS, do the following:

1. Press **<MENU>** repeatedly until **S--** shows on the display.
2. Press **<ENTER>**.
3. Use **<UP>** or **<DOWN>** to increase or decrease the speed, from **S. 1–100**.
4. Press **<ENTER>**. The display will return to the selected program.

Sound-Active Mode

To run the LED Shadow 2 ILS in sound-active mode, do the following:

1. Press **<MENU>** repeatedly until **Snd** shows on the display.
2. Press **<ENTER>**.



The product will only respond to low frequencies of music (bass and drums).

Sound Sensitivity

To set the sound sensitivity on the LED Shadow 2 ILS, do the following:

1. Press **<MENU>** repeatedly until **Sens** shows on the display.
2. Use **<UP>** or **<DOWN>** to increase or decrease the program speed, from **u 0–100**.
3. Press **<ENTER>**. The product will return to sound-active mode.

Manual Mode

To run the LED Shadow 2 ILS with a custom color and strobe speed, do the following:

1. Press **<MENU>** repeatedly until **u--** shows on the display.
2. Press **<ENTER>** and one of the following will show on the display:
 - **s. _ _ _** (strobe)
3. Use **<UP>** or **<DOWN>** to increase or decrease the value, from **0–255** (for dimmer) or from **0–100** (for the strobe speed: **0** is off, **1–99** is slow to fast, **100** is sound-active).
4. Press **<ENTER>**. to cycle through the options.
5. Repeat steps 3-4 until the product is set as desired.

Configuration (Settings)

Factory Reset

To reset the LED Shadow 2 ILS to factory default settings, do the following:

1. Press **<MENU>** repeatedly until **SEt** shows on the display.
2. Press **<ENTER>**.
3. Use **<UP>** or **<DOWN>** to select **rEst**.
4. Press **<ENTER>**.

IRC-6 Infrared Remote Control

The LED Shadow 2 ILS is compatible with the IRC-6 infrared remote control from Chauvet. To run the LED Shadow 2 ILS in IR mode, follow the instructions below.

1. Press **<MENU>** repeatedly until **SEt** shows on the display.
2. Press **<ENTER>**.
3. Use **<UP>** or **<DOWN>** to select **ir**.
4. Press **<ENTER>**.
5. Use **<UP>** or **<DOWN>** to select from **off** or **on**.
6. Press **<ENTER>**.

IRC-6 Operation

Automatic Programs

To run an automatic program with the IRC-6, press **<AUTO>**

1. Press **<AUTO>** on the IRC-6.
2. Press **<+>** or **<->** to select the program.

FADE

To run the FADE program with the IRC-6, press **<FADE>**.

1. Press **<FADE>** on the IRC-6.
2. Press **<+>** or **<->** to select the program.

To set the program speed with the IRC-6:

1. Press **<SPEED>** on the IRC-6.
2. Press **<+>** or **<->** to increase or decrease the speed.

Sound-Active Mode

To run the sound-active mode with the IRC-6, press **<SOUND>**.

To set the sound sensitivity with the IRC-6:

1. Press **<SENSITIVITY>** on the IRC-6.
2. Press **<+>** or **<->** to increase or decrease the sensitivity.

Manual Mode

To mix a custom color with the IRC-6:

1. Press **<MANUAL>** on the IRC-6.
2. Press **<R>** (red), **<G>** (green), **** (blue), or **<A>** (amber) to select which color to edit.
3. Press **<+>** or **<->** to increase or decrease the value of the selected color.

To select a preset color with the IRC-6:

1. Press **<MANUAL>** on the IRC-6.
2. Press **<P/UV>**, **<W>**, or **<0>-<9>** to select the color.

Strobe

To adjust the strobe rate with the IRC-6:

1. Press **<STROBE>** on the IRC-6.
2. Press **<+>** or **<->** to increase or decrease the strobe rate.
3. Press **<STROBE>** again to turn off the strobe, or set the strobe to **0**.

Black Out

To black out the lights with the IRC-6, press **<BLACK OUT>**.

This will turn off all the lights until the button is pressed again.

NOTE: The IRC-6 will not respond to any inputs when Black Out is activated. If the product does not respond when a button is pressed, try pressing **<BLACK OUT>**. Black Out may have been activated.

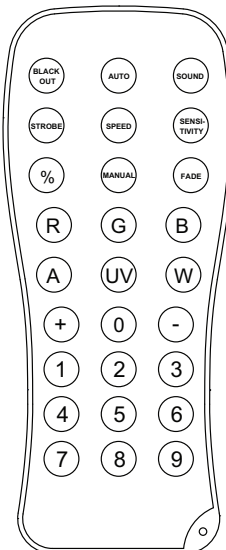

Master/Slave Mode (Wired)

The Master/Slave mode allows a single LED Shadow 2 ILS product (the “master”) to control the actions of one or more LED Shadow 2 ILS products (the “slaves”) without the need of a DMX controller. The master product will be set to operate in either standalone mode or with the IRC-6, while the slave products will be set to operate in slave mode. Once set and connected, the slave products will operate in unison with the master product.

Configure the products as indicated below.

Slave products:

1. Press **<MENU>** repeatedly until **4Ch** shows on the display.
2. Press **<ENTER>**.
3. Use **<UP>** or **<DOWN>** to select **d 1**.
4. Press **<ENTER>**.
5. Connect the DMX input of the first slave product to the DMX output of the master product.
6. Connect the DMX input of the subsequent slave products to the DMX output of the previous slave product.
7. Finish setting and connecting all the slave products.

Master product:

1. Set the master product to operate in standalone mode or with the IRC-6.
2. Make the master product the first product in the DMX daisy chain.



- **Configure all the slave products before connecting the master to the daisy chain.**
- **Never connect a DMX controller to a DMX string configured for Master/Slave operation because the controller may interfere with the signals from the master.**
- **Do not connect more than 31 slaves to the master.**

Master/Slave Mode (D-Fi USB)

The D-Fi USB allows a single LED Shadow 2 ILS product (the “master”) to control the actions of one or more LED Shadow 2 ILS products (the “slaves”) without the need of a DMX controller or DMX cables. The master (transmitter) product will be set to operate in standalone mode or with the IRC-6, while the slave (receiver) products will be set to operate in DMX mode. Once set and connected, the slave products will operate in unison with the master product.

Configure the products as indicated below.

Slave products:

1. Press **<MENU>** repeatedly until **4Ch** shows on the display.
2. Press **<ENTER>**.
3. Use **<UP>** or **<DOWN>** to set the starting address to **d 1**.
4. Press **<ENTER>**.
5. Set the D-Fi USB to receive on a specific channel, 1–16.
6. Plug in the D-Fi USB.
7. Finish setting and connecting all the slave products.

Master product:

1. Set the master product to operate in standalone mode.
2. Set the D-Fi USB to transmit on the D-Fi channel the slaves are receiving on.
3. Plug in the D-Fi USB.



- **All products must be set to the same DMX personality, DMX address, and D-Fi channel.**
- **Configure all the slave products before configuring the master to transmit.**
- **Never connect a DMX controller to a D-Fi channel configured for Master/Slave operation because the controller may interfere with the signals from the master.**

ILS Mode

ILS (Integrated Lighting System) provides 4 modes that synchronize with the GigBAR MOVE+ILS: Modes 1 and 3 synchronize with side 1 of the GigBAR MOVE+ILS, whereas modes 2 and 4 synchronize with side 2 of the GigBAR MOVE+ILS. When linked, effects will sync with the most similar effect on the selected side of the GigBAR MOVE+ILS: Kinta effects will sync with one of the kintas, wash effects will sync with one of the pars, etc. This product will synchronize with the par on the selected side of the GigBAR MOVE+ILS.

To set the LED Shadow 2 ILS to respond to an ILS signal:

1. Press **<MENU>** repeatedly until **iLS** shows on the display.
2. Press **<ENTER>**.
3. Use **<UP>** or **<DOWN>** to select from **iLS1** (side 1), **iLS2** (side 2), **iLS3** (side 1), or **iLS4** (side 2).
4. Press **<ENTER>**.

5. Maintenance

Product Maintenance

Dust build-up reduces light output performance and can cause overheating. This can lead to reduction of the light source's life and/or mechanical wear. To maintain optimum performance and minimize wear, clean your lighting products at least twice a month. However, be aware that usage and environmental conditions could be contributing factors to increase the cleaning frequency.

To clean the product, follow the instructions below:

1. Unplug the product from power.
2. Wait until the product is at room temperature.
3. Use a vacuum (or dry compressed air) and a soft brush to remove dust collected on the external surface/vents.
4. Clean all transparent surfaces with a mild soap solution, ammonia-free glass cleaner, or isopropyl alcohol.
5. Apply the solution directly to a soft, lint free cotton cloth or a lens cleaning tissue.
6. Softly drag any dirt or grime to the outside of the transparent surface.
7. Gently polish the transparent surfaces until they are free of haze and lint.



Always dry the transparent surfaces carefully after cleaning them.

6. Technical Specifications

Dimensions and Weight

Length	Width	Height	Weight
8.2 in (208 mm)	14 in (355 mm)	2.2 in (55 mm)	6 lb (2.8 kg)

Note: Dimensions in inches are rounded.

Power

Power Supply Type	Range	Voltage Selection
Switching (internal)	100 to 240 VAC, 50/60 Hz	Auto-ranging
Parameter	120 V, 60 Hz	230 V, 50 Hz
Consumption	49 W	49 W
Operating Current	0.7A	0.4 A
Power linking current (products)	8 A (11 products)	8 A (20 products)
Fuse	T1 A, 250 V	T1 A, 250 V
Power I/O	U.S./Worldwide	UK/Europe
Power input connector	IEC	IEC
Power output connector	Edison	IEC
Power Cord plug	Edison (U.S.)	Local Plug

Light Source

Type	Color	Quantity	Power	Current	Lifespan
LED	UV	18	3 W	0.6 A	50,000 hours

Photometrics

Strobe Rate	Coverage Angle
0 to 20 Hz	32°

Thermal

Maximum External Temperature	Cooling System
104 °F (40 °C)	Convection

DMX

I/O Connector	Channel Range
3-pin XLR	4

Ordering

Product Name	Item Code	UPC Number
LED Shadow 2 ILS	10121916	781462222642



Warranty & Returns

Limited Warranty

FOR WARRANTY REGISTRATION AND COMPLETE TERMS AND CONDITIONS PLEASE VISIT OUR WEBSITE.

For Customers in the United States and Mexico: www.chauvetlighting.com/warranty-registration.

For Customers in the United Kingdom, Republic of Ireland, Belgium, the Netherlands, Luxembourg, France, and Germany: www.chauvetlighting.eu/warranty-registration.

Chauvet warrants that this product shall be free from defects in material and workmanship under normal use, for the period specified in, and subject to the exclusions and limitations set forth in the full limited warranty on our website. This warranty extends only to the original purchaser of the product and is not transferable. To exercise rights under this warranty, you must provide proof of purchase in the form of an original sales receipt from an authorized dealer that shows the product name and date of purchase.

THERE ARE NO OTHER EXPRESS OR IMPLIED WARRANTIES. This warranty gives you specific legal rights. You may also have other rights that vary from state to state and country to country. This warranty is valid only in the United States, United Kingdom, Republic of Ireland, Belgium, the Netherlands, Luxembourg, France, Germany and Mexico. For warranty terms in other countries, please consult your local distributor.

Returns

In case support or return of product is needed:

- If located in the U.S., contact Chauvet World Headquarters.
- If located in the U.K. or Ireland, contact Chauvet U.K.
- If located in Benelux, contact Chauvet Benelux.
- If located in France, contact Chauvet France.
- If located in Germany, contact Chauvet Germany.
- If located in Mexico, contact Chauvet Mexico.
- If located in any other country, DO NOT contact Chauvet. Instead, contact your local distributor. See www.chauvetdj.com for distributors outside the U.S., U.K., Ireland, Benelux, France, Germany, or Mexico.



If located outside the U.S., U.K., Ireland, Benelux, France, Germany, or Mexico, contact the distributor of record and follow their instructions on how to return Chauvet products to them. Visit our website www.chauvetdj.com for contact details.

Call the corresponding Chauvet Technical Support office and request a Return Merchandise Authorization (RMA) number before shipping the product. Be prepared to provide the model number, serial number, and a brief description of the cause for the return.

To submit a service request online, go to www.chauvetdj.com/service-request.

Send the merchandise prepaid, in its original box, and with its original packing and accessories. Chauvet will not issue call tags.

Clearly label the package with the RMA number. Chauvet will refuse any product returned without an RMA number.



Write the RMA number on a properly affixed label. DO NOT write the RMA number directly on the box.

Before sending the product, clearly write the following information on a piece of paper and place it inside the box:

- Your name
- Your address
- Your phone number
- RMA number
- A brief description of the problem

Be sure to pack the product properly. Any shipping damage resulting from inadequate packaging will be your responsibility. FedEx packing or double-boxing are recommended.



Chauvet reserves the right to use its own discretion to repair or replace returned product(s).

Contact Us

General Information	Technical Support
Chauvet World Headquarters	
Address: 3360 Davie Rd. Davie, FL 33314 Voice: (954) 577-4455 Fax: (954) 929-5560 Toll Free: (800) 762-1084	Voice: (844) 393-7575 Fax: (954) 756-8015 Email: chauvetcs@chauvetlighting.com Website: www.chauvetdj.com
Chauvet U.K.	
Address: Unit 1C Brookhill Road Industrial Estate Pinxton, Nottingham, UK NG16 6NT Voice: +44 (0) 1773 511115 Fax: +44 (0) 1773 511110	Email: UKtech@chauvetlighting.eu Website: www.chauvetdj.eu
Chauvet Benelux	
Address: Stokstraat 18 9770 Kruishoutem Belgium Voice: +32 9 388 93 97	Email: BNLtech@chauvetlighting.eu Website: www.chauvetdj.eu
Chauvet France	
Address: 3, Rue Ampère 91380 Chilly-Mazarin France Voice: +33 1 78 85 33 59	Email: FRtech@chauvetlighting.fr Website: www.chauvetdj.eu
Chauvet Germany	
Address: Bruno-Bürgel-Str. 11 28759 Bremen Germany Voice: +49 421 62 60 20	Email: DEtech@chauvetlighting.de Website: www.chauvetdj.eu
Chauvet Mexico	
Address: Av. de las Partidas 34 - 3B (Entrance by Calle 2) Zona Industrial Lerma Lerma, Edo. de México, CP 52000 Voice: +52 (728) 690-2010	Email: servicio@chauvet.com.mx Website: www.chauvetdj.mx

Visit the applicable website above to verify our contact information and instructions to request support. Outside the U.S., U.K., Ireland, Mexico, France, Germany, or Benelux, contact the dealer of record.